



## Echotel® Model 300/301 Ultrasonic Non-Contact Transmitter For Level, Volume, and Open Channel Flow

### DESCRIPTION

---

The Model 300/301 is a full-featured, powerful ultrasonic system for measurement of liquid level, volume, or open channel flow. Available as an integral or remote mounted transmitter, this extremely versatile system is simple to install and calibrate. The non-contact design means that it is not affected by changes in specific gravity, viscosity, or conductivity.

### FEATURES

---

- Isolated 4–20 mA output includes an active/passive mode for loop power or device power.
- RS-485 with Modbus protocol allows bi-directional communication with DCS or PLC.
- Two or four 10 amp SPDT gold flash relays provide flexibility for most alarm and control schemes.
- 16-button keypad and two-line, 16-character LCD alphanumeric display.
- Temperature compensation integral to ultrasonic transducer.
- Output in units of level, volume, or open channel flow.
- Most common flumes and weirs preprogrammed in memory in addition to the Manning formula and a custom table using either a linear or spline curve.
- Complete self-diagnostics checks all relays, outputs, and system functionality.
- Class I, Div. 1, Groups B, C, and D on both the transmitter and transducer.
- QuickCal mode allows complete system calibration in 90 seconds.
- Powerful 38 kHz EchoMaster™ ultrasonic transducer performs in difficult applications.
- Password protection prevents unwanted tampering with configuration data.



### APPLICATIONS

---

- Water and wastewater
- Slurries
- Viscous fluids
- Acids
- Oils
- Caustics

# TECHNOLOGY

The Model 300/301 is a versatile system that utilizes non-contact ultrasonic technology to measure liquid levels in a variety of applications. The system consists of a transmitter and an ultrasonic transducer. The transducer contains a piezoelectric crystal that has the ability to convert electrical signals generated by the transmitter into ultrasonic pulses.

The unit operates by directing ultrasonic pulses, or sound waves, through the air toward the liquid surface.

They are then reflected off the liquid surface as an echo, and returned to the transducer. The piezoelectric crystal then converts the returned echo into an electrical signal which is analyzed by the transmitter. The elapsed time between the generation of the ultrasonic pulse and the return echo is proportional to the distance between the face of the transducer and the liquid surface.

# TYPICAL MOUNTING CONFIGURATIONS

The transducer is installed above the liquid surface. A minimum dead zone distance of 18" (457 mm) must be allowed between the face of the transducer and the maximum attainable level. Figure 1 shows a typical open

channel flow installation with the transducer mounted on a bracket. Figure 2 shows how the unit can be mounted in a coupling or flange for level or volume applications.

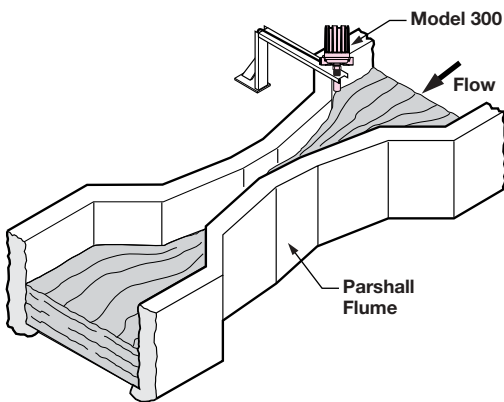

**Figure 1**  
**Typical Mounting - Open Channel Flow**

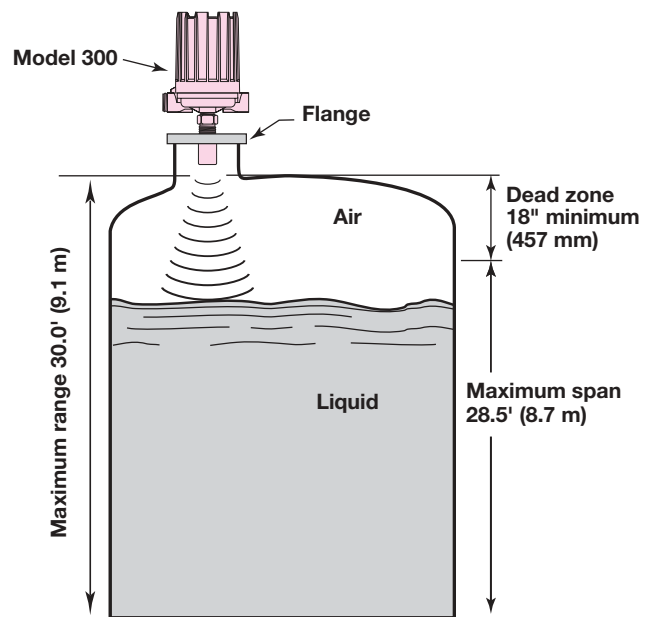
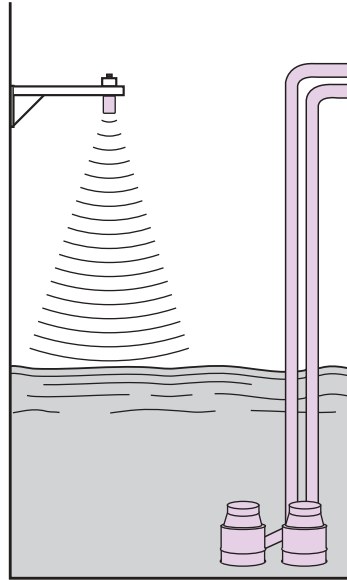

**Figure 2**  
**Typical Mounting - Level/Volume**

# TYPICAL MOUNTING CONFIGURATIONS

Figure 3 shows how the transducer can often be mounted further down in a wet well or sump if the liquid will never reach the top of the vessel. This helps to keep the

12 degree ultrasonic beam away from pumps, ladders, side walls, or other obstructions in the vessel.



**Figure 3**  
**Typical Transducer Mounting - Wet Well or Sump**



## ULTRASONIC BEAM ANGLE

A 12° conical beam of ultrasonic energy is emitted from the face of the transducer. The transducer should be mounted in a location such that the ultrasonic signal does not touch the side walls or any other obstructions in the vessel. This is typically accomplished by using a bracket, half-coupling, or rigid conduit to mount the transducer in a spot where a strong echo can be received off of the

liquid surface. The chart below shows the distance the transducer should be located away from side walls and obstructions. The distances are based on a 6° beam radius at different heights above the liquid surface. Generally speaking, the transducer should be mounted one foot away for every 10 feet of height.

Distance from Transducer Face (feet)	12° Beam Diameter (feet)	Minimum Distance from Wall or Obstruction (inches)
3'	0.6'	4"
6'	1.3'	8"
9'	1.9'	11"
12'	2.5'	15"
15'	3.2'	19"
18'	3.8'	23"
21'	4.4'	26"
24'	5.0'	30"
27'	5.7'	34"
30'	6.3'	38"
33'	6.9'	42"

# AGENCY APPROVALS

AGENCY	MODEL	PROTECTION METHOD	AREA CLASSIFICATION
<b>FM</b>  APPROVED	300-RXXX-45X 301-RXXX-400 with 384-XKXX-0XX	Indoors & Outdoors	NEMA Type 4X & IP 65
		Hazardous locations	Class I, Div. 1; Groups B, C & D Class II, Div. 1; Groups E, F & G Class III
<b>CSA</b> 	300-RXXX-45X 301-RXXX-400 with 384-XKXX-0XX	Non-hazardous	TYPE 4X enclosure
	300-RXXX-45X 301-RXXX-400 with 384-XK0X-0XX	Hazardous locations	Class I, Div. 1; Groups B, C & D Class II, Div. 1; Groups E, F & G Class III
	384-XK1X-0XX and 384-XKYX-0XX	Hazardous locations	Class I, Div. 1; Groups C & D Class II, Div. 1; Groups E, F & G Class III

 These units have been tested to EN 50081-2 and EN 50082-2 and are in compliance with the EMC Directive 89/336/EEC.

# DIMENSIONAL SPECIFICATIONS

INCHES (MM)

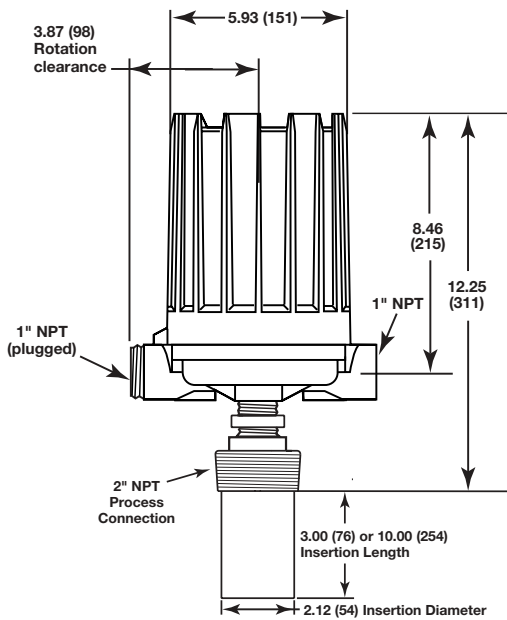

**Model 300 Integral Mount**

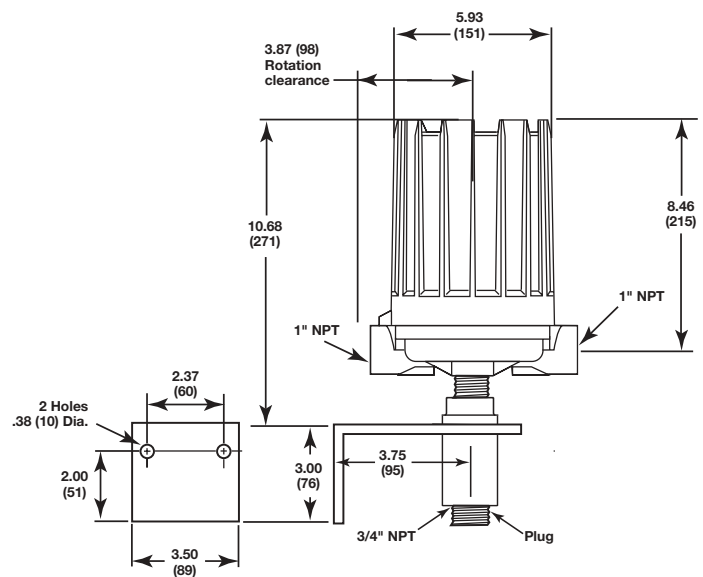

**Model 301 Remote Mount with Bracket**

# DIMENSIONAL SPECIFICATIONS

INCHES (MM)

## MODEL 384 TRANSDUCERS

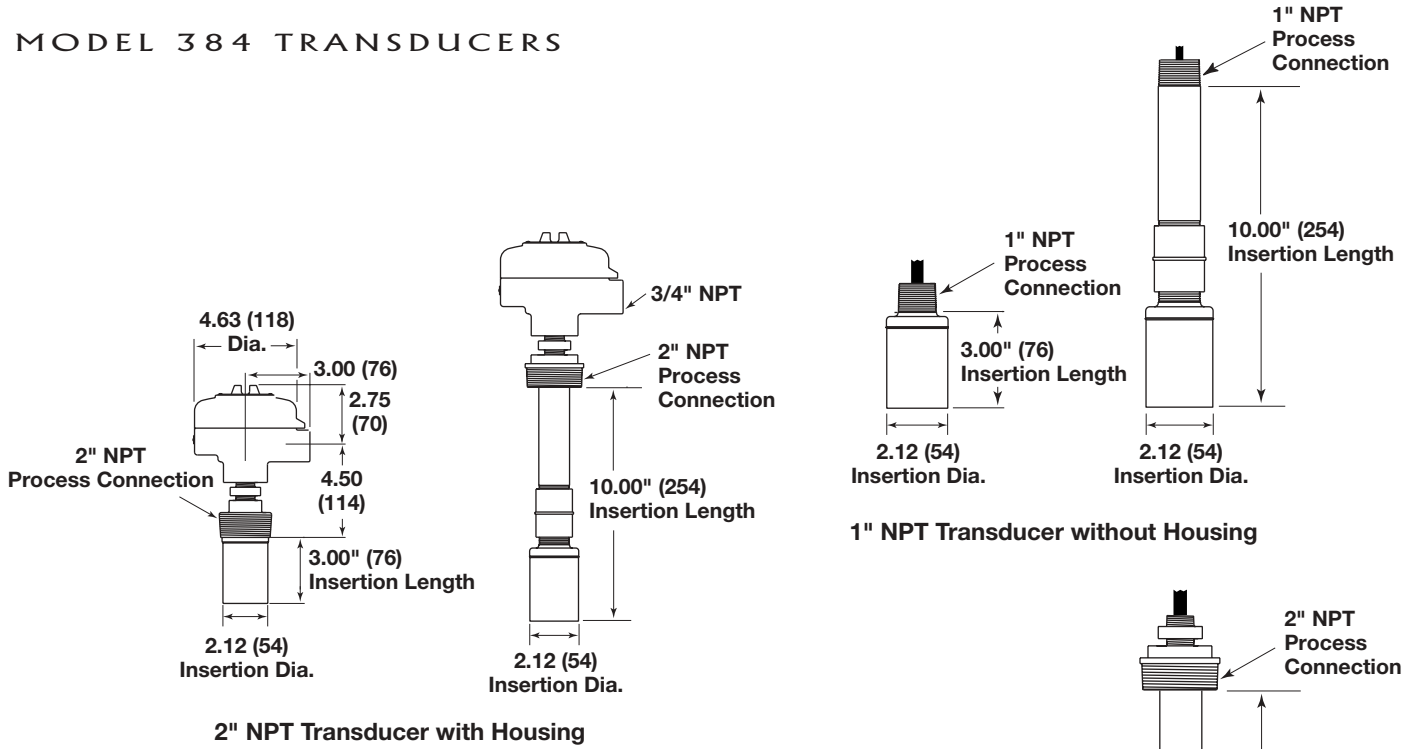

1" NPT Transducer without Housing

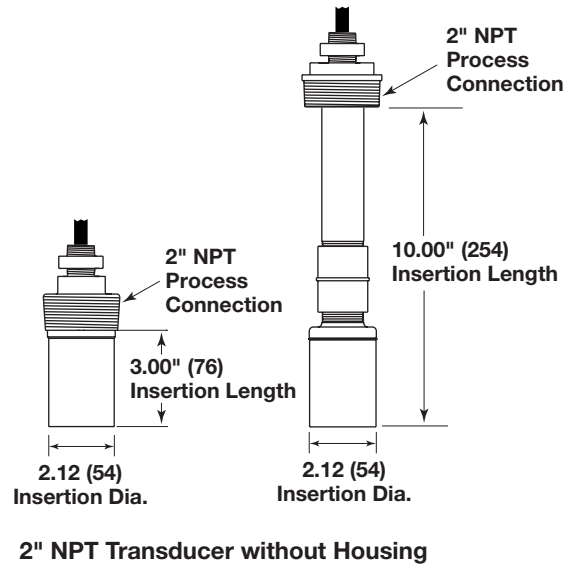

2" NPT Transducer without Housing

## OPTIONAL MOUNTING BRACKETS

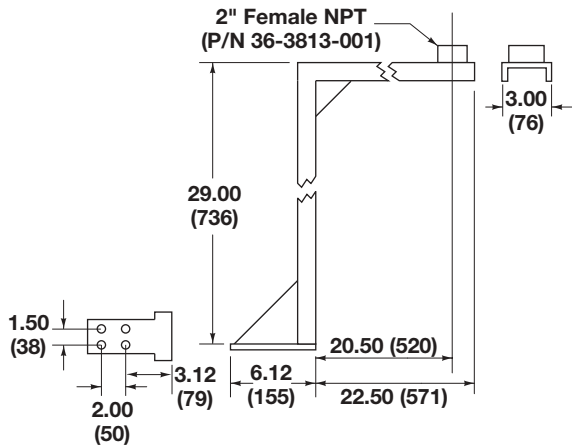

Floor Mount Bracket

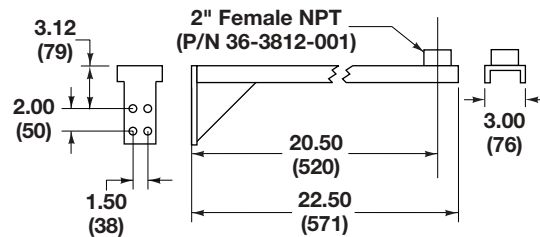

Wall Mount Bracket

# MEASUREMENT RANGE CALCULATIONS

## MEASUREMENT RANGE EXPECTATIONS

Ultrasonic non-contact devices are typically rated for a maximum range in ideal conditions. Experience has shown that maximum range must be adjusted for certain factors. Although the maximum range rating is somewhat conservative, each application must be evaluated for specific conditions.

The operating parameters listed below can impact the maximum range of measurement:

- Surface agitation
- Vapors and steam (as measured by temperature difference between liquid and air)
- Beam spread interference
- Sensor alignment
- Foam
- Dust
- Air movement
- Ambient temperature
- Pressure

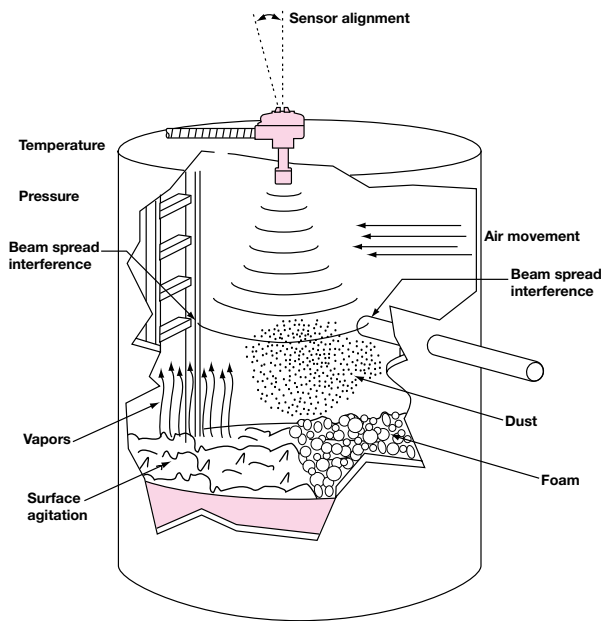

## HOW TO CALCULATE

To estimate how successful a particular application may be, using the chart on page 3:

1. Select **one** condition from each of the operating parameters that best describes your application.
2. Enter the corresponding performance multiplier value in the application column.
3. Multiply all values together.
4. Obtain the maximum range from the table below that corresponds to your switch or transmitter model.
5. Multiply step 3 by step 4; this yields a value that is the maximum allowable measurement range for this application.

### Example:

The vessel is a closed-top tank, uninsulated, 22 feet tall.

- |                    |  |
|--------------------|--|
| Surface agitation: | Expect slight agitation from fill line.<br>Performance multiplier 0.9                          |
| Vapor and steam:   | The process temperature is +130° F;<br>slight vapor is expected.<br>Performance multiplier 0.9 |
| Beam interference: | No interference exists.<br>Performance multiplier 1.0  |
| Sensor alignment:  | The sensor will be perpendicular to<br>the liquid surface.<br>Performance multiplier 1.0       |
| Foam:              | None. Performance multiplier 1.0   |
| Dust:              | None. Performance multiplier 1.0   |
| Air movement:      | None. Performance multiplier 1.0   |
| Ambient temp.:     | 0 to +120° F. Performance multiplier 1.0   |
| Pressure:          | Atmospheric pressure.<br>Performance multiplier 1.0  |

Will the Model 300 work for this application?

### Calculation:

Multiplied values of all application columns:  
 $0.9 \times 0.9 \times 1.0 \times 1.0 \times 1.0 \times 1.0 \times 1.0 \times 1.0 \times 1.0 \times 1.0$   
30 feet (maximum) = **24.3 feet**

The calculation yields 24.3 feet as the new maximum range. Since the tank is 22 feet tall, this application will give satisfactory results.

NOTE: The performance estimates provided are conservative estimates. Since these factors are subjective, the estimates have been designed to provide very high confidence of system success. Contact the factory if there are any questions concerning the interpretation of any of these values.

# MEASUREMENT RANGE CALCULATIONS

OPERATING PARAMETER	CONDITION	PERFORMANCE MULTIPLIER	APPLICATION
<p><b>SURFACE AGITATION:</b> Surface agitation or waves can degrade the performance. Moderate agitation results in only slight degradation of performance. The worst case is when the surface is a good reflector, but in the wrong direction. (Refer to sensor alignment.)</p>	Smooth, glass-like surface . . . . .	1.0	
	Slight agitation, choppiness . . . . .	0.9	
	Heavy agitation . . . . .	0.8	
	Slight vortex . . . . .	0.7	
<p><b>VAPOR AND STEAM:</b> Vapors in the air space, above the process, become apparent, and cause problems when the liquid process temperature is well above the temperature of the airspace. The greater the difference, the more expected vapor problems. The problems result from condensation or layering in the sound path, both of which attenuate the sound signal, degrading performance. Avoid steam if possible.</p> <p>To avoid these problems, ensure that the vessel is insulated so that vapors are less likely to condense. If a vent is used, be sure that the vent, which is where condensation will form, is well away from the sensor.</p>	No condensation . . . . .	1.0	
	Little condensation . . . . .	0.9	
	Much condensation/ foggy appearance . . . . .	0.8	
<p><b>BEAM SPREAD INTERFERENCE:</b> It is strongly recommended that nothing be allowed within the sensor's beam, except the liquid which is being monitored. Often, the signal from the liquid will be strong, compared to the signal from other sources, such as, ladder rungs filling process material, support struts, etc. For that reason, some applications may provide satisfactory results, even with than 60 interference. Interference from agitator blades is only an intermittent interference that usually has little effect on performance.</p> <p>It is recommended there be no interference within the 6° half angle of the sensor beam. If interference is unavoidable, make the interference as far as possible from the sensor so that the real signal at the longest distance is stronger than the interference signal.</p>	No interference within 3.5° half beam angle . . . . .	1.0	
	Agitator at speed less than 60 RPM . . .	1.0	
	Agitator at speed greater than 60 RPM . . . . .	Consult factory	
	Interference outside 4°, far from sensor (in bottom third of range) . . . . .	0.8	
<p><b>SENSOR ALIGNMENT:</b> Optimum performance is obtained when the sensor is perfectly aligned. If the process is not perpendicular to the sound beam, the sound will not reflect properly back to the sensor. The effect is significant.</p>	Beam perpendicular to liquid surface . .	1.0	
	Beam 4° off from perpendicular . . . . .	0.5	
<p><b>FOAM:</b> Even small thicknesses of foam can attenuate the ultrasound and render the system inoperative. If possible, moving the sensor to an area in the tank where there is less foam, will improve the performance. Thick, heavy density foams can sometimes produce a reflection from the top of the foam. The multipliers shown at right are general guidelines. For further assistance consult the factory.</p>	No foam . . . . .	1.0	
	Light froth, less than 0.25" thick . . . . .	0.8	
	Light foam, less than 0.5" thick . . . . .	0.5	
	Light foam, more than 1" thick . . . . .	0.1	
<p><b>DUST:</b> Dust attenuates the sound and results in poor performance. Even barely perceptible haze in the air can cause significant attenuation.</p>	No dust . . . . .	1.0	
	Haze, barely perceptible . . . . .	0.7	
	Slight dust . . . . .	0.4	
	Heavy dust . . . . .	0.1	
<p><b>AIR MOVEMENT:</b> The movement of air, as possible in an open top vessel, can create a layer from which the sound will reflect. This will be most noticeable in applications where vapors or steam tend to form.</p>	No air movement . . . . .	1.0	
	Open vessel, but sensor below rim . . .	0.8	
	Open air movement in sound path . . .	0.7	
<p><b>AMBIENT TEMPERATURE:</b> The ambient temperature can have a significant effect on the sound and on the sensor's capability to transmit and receive sound. The most noticeable effect on the sensor is at the temperature extremes.</p>	-20° to +140° F (-29° to +50° C) . . . . .	1.0	
	-40° to -20° F (-40° to +29° C) . . . . .	0.9	
	+140° to +160° F (+50° to +70° C) . . .	0.9	
<p><b>PRESSURE:</b> Sound requires air molecules to be able to travel. Sound will not travel in a vacuum. Likewise, higher pressures will allow the sound to continue without decay, which can cause problems with multiple echoes.</p>	-10° to +50 psig (0.689 to +3.45 bar) . .	1.0	
	Pressures outside above rating . . . . .	Consult factory	
<b>Multiply all values together in the application column</b>			
<b>Choose a range value from the Maximum Range Table</b>			<b>X</b>
<b>Maximum allowable measurement range for this application</b>			

## TRANSMITTER SPECIFICATIONS

---

Supply voltage		120 VAC +10%/-15%, 50-60 Hz
		240 VAC +10%/-15%, 50-60 Hz
		24 VDC, $\pm 20\%$
Power consumption		12 watts (without heater)
Analog output signal	Active mode	4–20 mA (isolated) maximum 1,000 $\Omega$ loop resistance
	Passive mode	4–20 mA (isolated) loop resistance dependent on power supply (32 volt maximum) 1,000 $\Omega$ @ 24 volts
Digital output		RS-485 with Modbus
Relays		10 amp SPDT resistive (none, 2, or 4)
Fail-safe		User selectable for analog and relay outputs
Ambient Temperature	Electronics	-40° to +160° F (-40° to +71° C)
Display		Two-line alphanumeric LCD (16 characters per line)
Keypad		16-button
Humidity	Electronics	99% non-condensing
Fuse (Non-replaceable)		$\frac{3}{8}$ amp, 250 VAC Slo-Blo® for AC units
		1½ amp, 250 VDC Slo-Blo® for DC units

## TRANSDUCER SPECIFICATIONS

---

Transducer Frequency		38 kHz
Maximum Range		30 feet (9.1 m)
Maximum Span		28.5 feet (8.7 m)
Deadband		18 inches (460 mm) minimum
Ambient Temperature	Transducer	-40° to +163° F (-40° to +73° C)
		non-operational to +250° F (121° C)
Temperature Compensation		Automatic over range of transducer operating temperature
Operating Pressure		-10 to +50 psig (-0.689 to +3.45 bar)
Beam Angle		Conical 12°
Cable length		500 feet maximum (between transducer and electronics)

## PERFORMANCE SPECIFICATIONS

---

Response time		2 seconds typical
Accuracy		$\pm 0.25\%$ of calibrated span

# 300 INTEGRALLY MOUNTED TRANSMITTER

## MODEL NUMBER



Models available for quick shipment, usually within one week after factory receipt of a purchase order, through the Expedite Ship Plan (ESP)

### BASIC MODEL NUMBER

300	Integrally mounted transmitter
-----	--------------------------------

### INPUT POWER

0	120 VAC, 50/60 kHz
1	240 VAC, 50/60 kHz
2	24 VDC

### OUTPUT SIGNAL

1	4-20 mA isolated
3	RS-485 with Modbus
5	4-20 mA & RS-485 with Modbus

### RELAY OUTPUT

0	No relays
C	Two 10-amp SPDT relays with gold flash contacts
D	Four 10-amp SPDT relays with gold flash contacts

### TRANSDUCER

G	2" NPT Kynar, 3" insertion length,
L	2" NPT Kynar, 10" insertion length

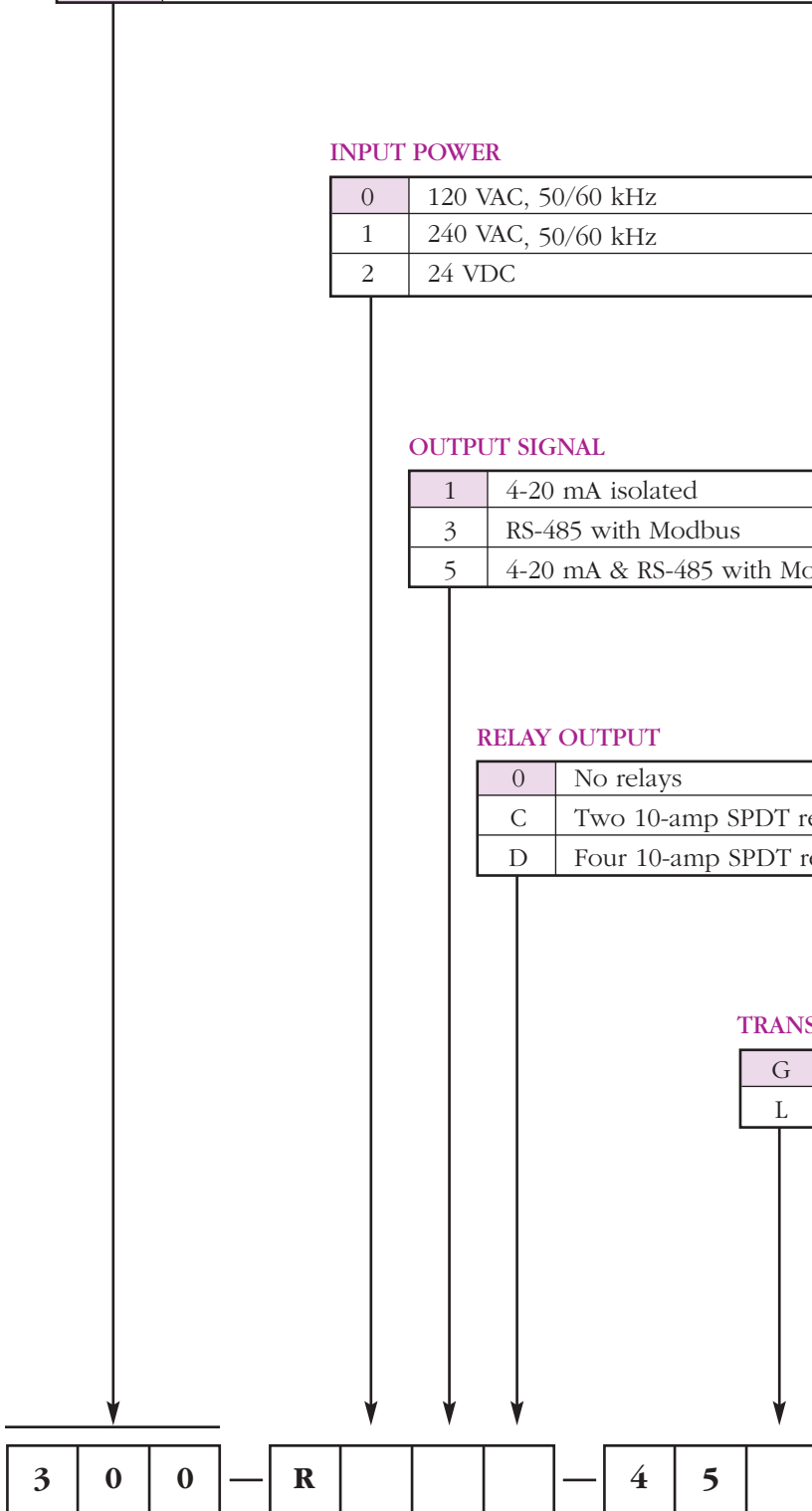

# 301 REMOTE MOUNTED TRANSMITTER

## MODEL NUMBER

Models available for quick shipment, usually within one week after factory receipt of a purchase order, through the Expedite Ship Plan (ESP)

### BASIC MODEL NUMBER

301	Remote mounted transmitter
-----	----------------------------

### INPUT POWER

0	120 VAC, 50/60 kHz
1	240 VAC, 50/60 kHz
2	24 VDC

### OUTPUT SIGNAL

1	4-20 mA isolated
3	RS-485 with Modbus
5	4-20 mA & RS-485 with Modbus

### RELAY OUTPUT

0	No relays
C	Two 10-amp SPDT relays with gold flash contacts
D	Four 10-amp SPDT relays with gold flash contacts



# MODEL 384 KYNAR TRANSDUCER

## MODEL NUMBER

### PROCESS CONNECTION

2	1" NPT, not available with transducer housing code 1 or Y
5	2" NPT

### TRANSDUCER HOUSING

0	No housing, 35' (10.7 m) of cable potted into transducer
1	Cast aluminum, NEMA 4X/7/9 housing with 3/4" NPT single conduit, connecting cable ordered separately
Y	316 stainless steel, NEMA 4X/7/9 housing with 3/4" NPT single conduit connecting cable ordered separately

### TRANSDUCER MOUNTING BRACKET ①

0	No mounting bracket
3	Wall mount bracket for 2" NPT process connection only
4	Floor mount bracket for 2" NPT process connection only

① Transducer mounting bracket not available with 1" NPT process connection.

### TRANSDUCER INSERTION LENGTH

003	3" (76 mm) length
010	10" (254 mm) length



## CONNECTING CABLE

### PART NUMBER

### CABLE LENGTH IN FEET

10 feet (3 m) minimum, 500 feet (152 m) maximum length  
 Example: 12 foot cable length = 037-3170-012

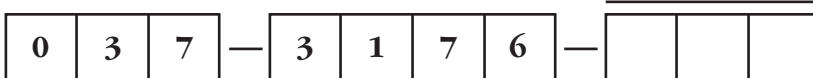

## QUALITY

---



The quality assurance system in place at Magnetrol guarantees the highest level of quality throughout the company. Magnetrol is committed to providing full customer satisfaction both in quality products and quality service.

Magnetrol's quality assurance system is registered to ISO 9001 affirming its commitment to known international quality standards providing the strongest assurance of product/service quality available.

## ESP

---

### Expedite Ship Plan

Several Echotel Model 300/301 Ultrasonic Level Transmitters are available for quick shipment, usually within one week after factory receipt of a purchase order, through the Expedite Ship Plan (ESP).

Models covered by ESP service are conveniently color coded in the selection data charts.

To take advantage of ESP, simply match the color coded model number codes (standard dimensions apply).

ESP service may not apply to orders of ten units or more. Contact your local representative for lead times on larger volume orders, as well as other products and options.

## WARRANTY

---



All Magnetrol electronic level and flow controls are warranted free of defects in materials or workmanship for one full year from the date of original factory shipment.

If returned within the warranty period; and, upon factory inspection of the control, the cause of the claim is determined to be covered under the warranty; then, Magnetrol will repair

or replace the control at no cost to the purchaser (or owner) other than transportation.

Magnetrol shall not be liable for misapplication, labor claims, direct or consequential damage or expense arising from the installation or use of equipment. There are no other warranties expressed or implied, except special written warranties covering some Magnetrol products.



5300 Belmont Road • Downers Grove, Illinois 60515-4499 • 630-969-4000 • Fax 630-969-9489 • [www.magnetrol.com](http://www.magnetrol.com)  
145 Jardin Drive, Units 1 & 2 • Concord, Ontario Canada L4K 1X7 • 905-738-9600 • Fax 905-738-1306  
Heikenstraat 6 • B 9240 Zele, Belgium • 052 45.11.11 • Telex 25944 • Fax 052 45.09.93  
Regent Business Ctr., Jubilee Rd. • Burgess Hill, Sussex RH15 9TL U.K. • 01444-871313 • Fax 01444-871317

Copyright © 2003 Magnetrol International, Incorporated. All rights reserved. Printed in the USA.  
Magnetrol and Magnetrol logotype are registered trademarks of Magnetrol International.

Performance specifications are effective with date of issue and are subject to change without notice.  
The brand and product names contained within this document are trademarks or registered trademarks of their respective holders.

**BULLETIN: 51-130.1**  
**EFFECTIVE: May 2003**  
**SUPERSEDES: June 1999**